

WWW.NDT.IT

info@ndt.it

***POLVERI MAGNETICHE FLUORESCENTI
PER APPLICAZIONI A LUCE VISIBILE***

14 Congresso AiPnD

Firenze, 26 Ottobre 2011

- 
- 1. Le Nuove ASME Art. V sez.7**
 - 2. La Luminescenza delle Polveri Magnetiche Fluorescenti**
 - 3. Le prove effettuate**
 - 4. Conclusioni**

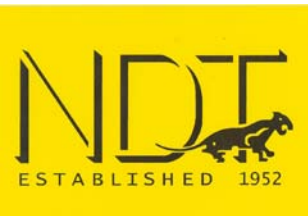

Le Nuove ASME Art. V sez.7

CND con Particelle Magnetiche Fluorescenti in condizioni di utilizzo “non standard”

Condizioni Standard

- Luce UV > 10 W/m² (= 1.000 microWatt / cm²)
- Luce visibile < 20 lx

ASME 2010 Sez.V Art.7

Appendix III

APPENDIX III — MAGNETIC PARTICLE EXAMINATION USING THE YOKE TECHNIQUE WITH FLUORESCENT PARTICLES IN AN UNDARKENED AREA

III-710 SCOPE

This Appendix provides the Magnetic Particle examination methodology and equipment requirements applicable for performing Magnetic Particle examinations using a yoke with fluorescent particles in an undarkened area.

III-720 GENERAL

Requirements of Article 7 apply unless modified by this Appendix.

Appendix IV

APPENDIX IV — QUALIFICATION OF ALTERNATE WAVELENGTH LIGHT SOURCES FOR EXCITATION OF FLUORESCENT PARTICLES

IV-710 SCOPE

This Appendix provides the methodology to qualify the performance of fluorescent particle examinations using alternate wavelength sources.

IV-720 GENERAL

Requirements of Article 7 apply unless modified by this Appendix.

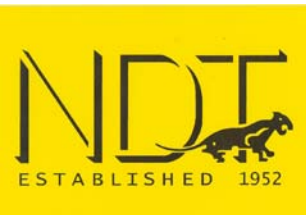

Le Nuove ASME Art. V sez.7

“Essential Variables”

TABLE III-721
REQUIREMENTS FOR AN AC OR HWDC YOKE TECHNIQUE WITH FLUORESCENT PARTICLES
IN AN UNDARKENED AREA

Requirement	Essential Variable	Nonessential Variable
Identification of surface configurations to be examined and product forms (e.g., base material or welded surface)	X	...
Surface condition requirement and preparation methods	X	...
Yoke manufacturer and model	X	...
Particle manufacturer and designation ←	X	...
Minimum and maximum pole separation	X	...
Identification of steps in performing the examination	X	...
Maximum white light intensity	X	...
Minimum black light intensity	X	...
Personnel qualification requirements	...	X
Reference to the procedure qualification records	...	X

TABLE IV-721
REQUIREMENTS FOR QUALIFYING ALTERNATE WAVELENGTH LIGHT SOURCES
FOR EXCITATION OF SPECIFIC FLUORESCENT PARTICLES

Requirement	Essential Variable	Nonessential Variable
Particle manufacturer and designation ←	X	...
Carrier (water or oil); if oil, manufacturer and type designation	X	...
Alternate wavelength light source manufacturer and model	X	...
Alternate wavelength light source meter, manufacturer, and model	X	...
Filter glasses (if needed)	X	...
Minimum alternative wavelength light intensity	X	...
Qualification records	...	X

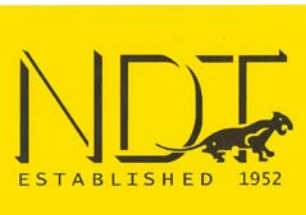

Le Nuove ASME Art. V sez.7

“Essential Variables”

TABLE T-721
REQUIREMENTS OF A MAGNETIC PARTICLE EXAMINATION PROCEDURE

Requirement	Essential Variable	Nonessential Variable
Magnetizing technique	X	...
Magnetizing current type or amperage outside range specified by this Article or as previously qualified	X	...
Surface preparation	X	...
Magnetic particles (fluorescent/visible, color, particle size, wet/dry) ←	X	...
Method of particle application	X	...
Method of excess particle removal	X	...
Minimum light intensity	X	...
Existing coatings, greater than the thickness demonstrated	X	...
Nonmagnetic surface contrast enhancement, when utilized	X	...
Performance demonstration, when required	X	...
Examination part surface temperature outside of the temperature range recommended by the manufacturer of the particles or as previously qualified	X	...
Shape or size of the examination object	...	X
Equipment of the same type	...	X
Temperature (within those specified by manufacturer or as previously qualified)	...	X
Demagnetizing technique	...	X
Post-examination cleaning technique	...	X
Personnel qualification requirements	...	X

Valutazione della Luminescenza di PMF

ISO 9934-2 Vs. ASTM E1135

ISO 9934-2

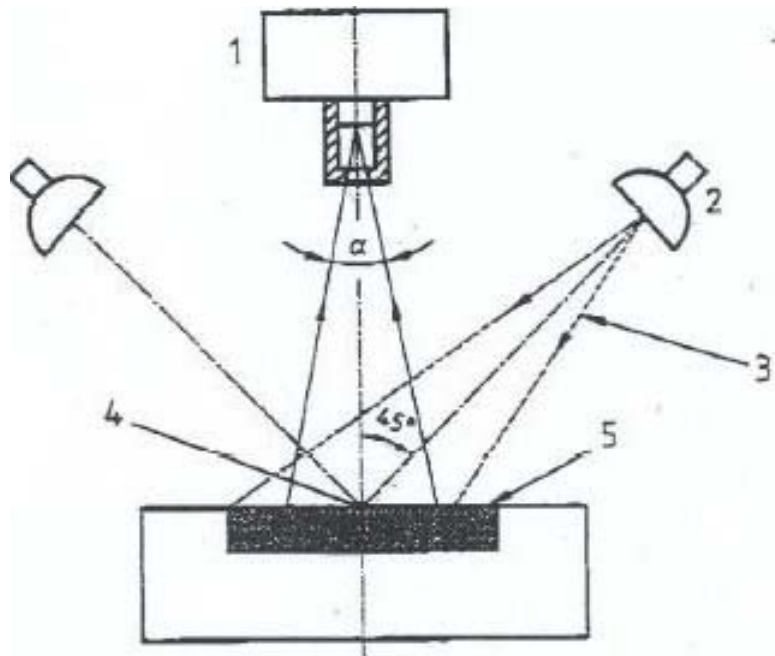

 E1135

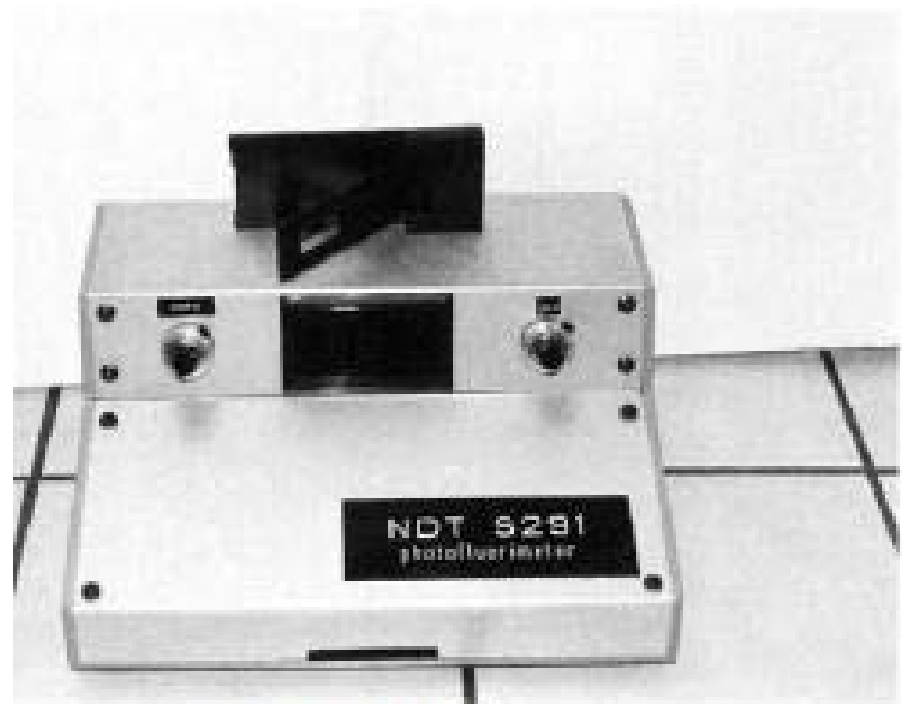

FIG. 5 Sample Holder

Valutazione della Luminescenza di PMF

I Campioni sotto esame

Sigla	Colore a luce ambiente	Granulometria dichiarata
G 8	verde scura	fine
G 9	verde medio	media
G 6	rossa	media
M 1	marrone	fine
M 4	verde medio	media
L	verde chiaro	media
A	marrone	fine
K	marrone chiaro	fine
C 1	marrone	fine
FW 1 *	verde medio	fine

* La FW1 fa parte della linea Elite prodotta dalla NDT ITALIANA

Valutazione della Luminescenza di PMF

I risultati ottenuti secondo la ASTM E-1135

Sigla	% Misurata	Differenza %
G 8	100 (posta a 100 come riferimento)	0
G 9	180	+80
G 6	60	-40
M 1	70	-30
M 4	140	+40
L	300	+200
A	40	-60
K	90	-10
C 1	50	-50
FW 1 *	220	+120

* La FW1 fa parte della linea Elite prodotta dalla NDT ITALIANA

Le prove effettuate

Foto A): blocco di riferimento tipo 1 della ISO 9934-2 (ASTM E 1444)

Luce UV: 15 W/m²; Luce bianca: < 20 Lux

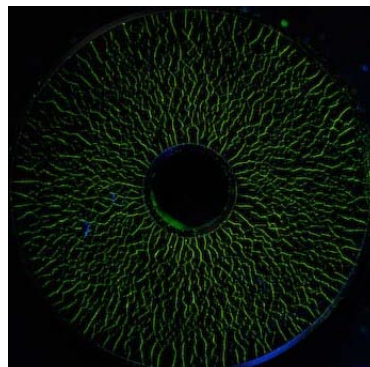
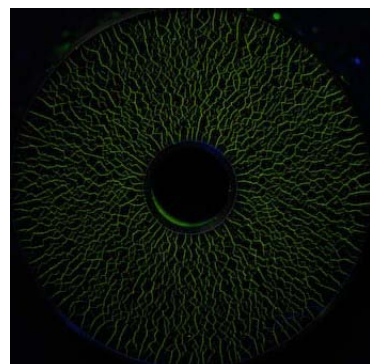
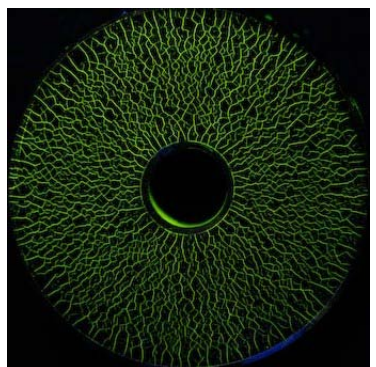
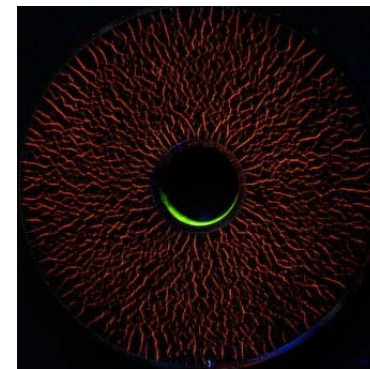
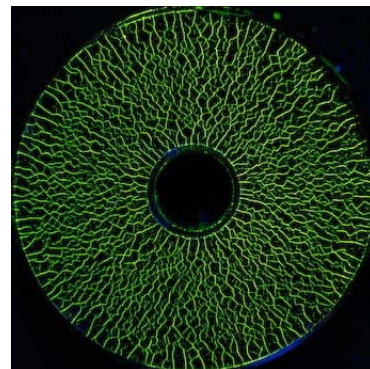
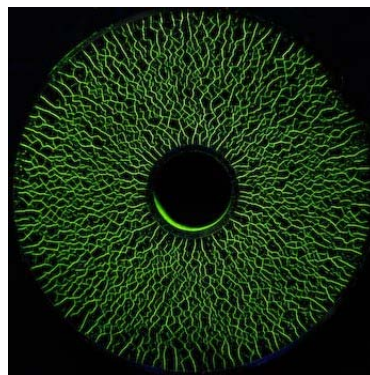
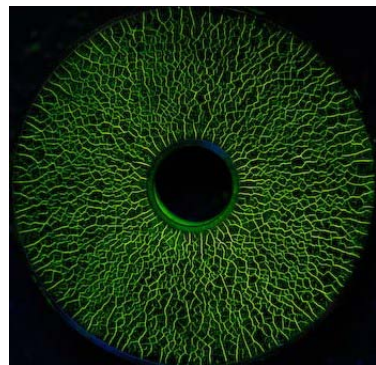
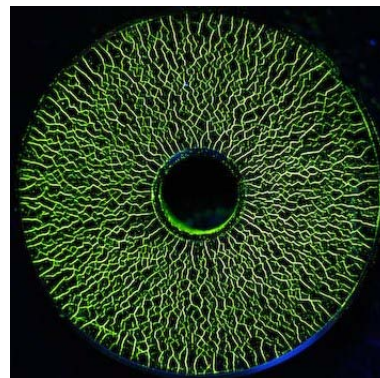
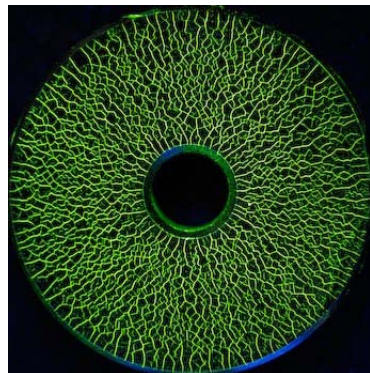
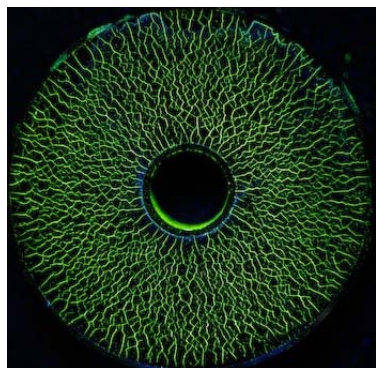

Le prove effettuate

Foto A): blocco di riferimento tipo 1 della ISO 9934-2 (ASTM E 1444)

Luce UV: 15 W/m²; Luce bianca: < 20 Lux

G8 (riferimento posto a "100")

C1 (polvere a bassa luminosità)

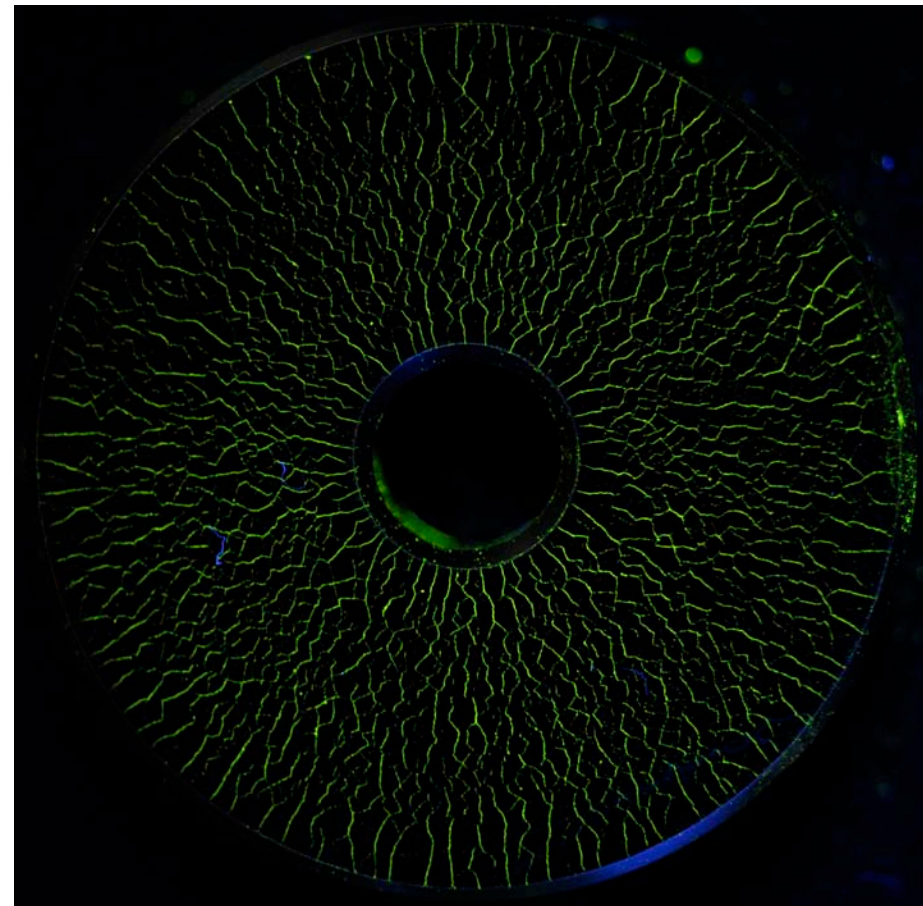
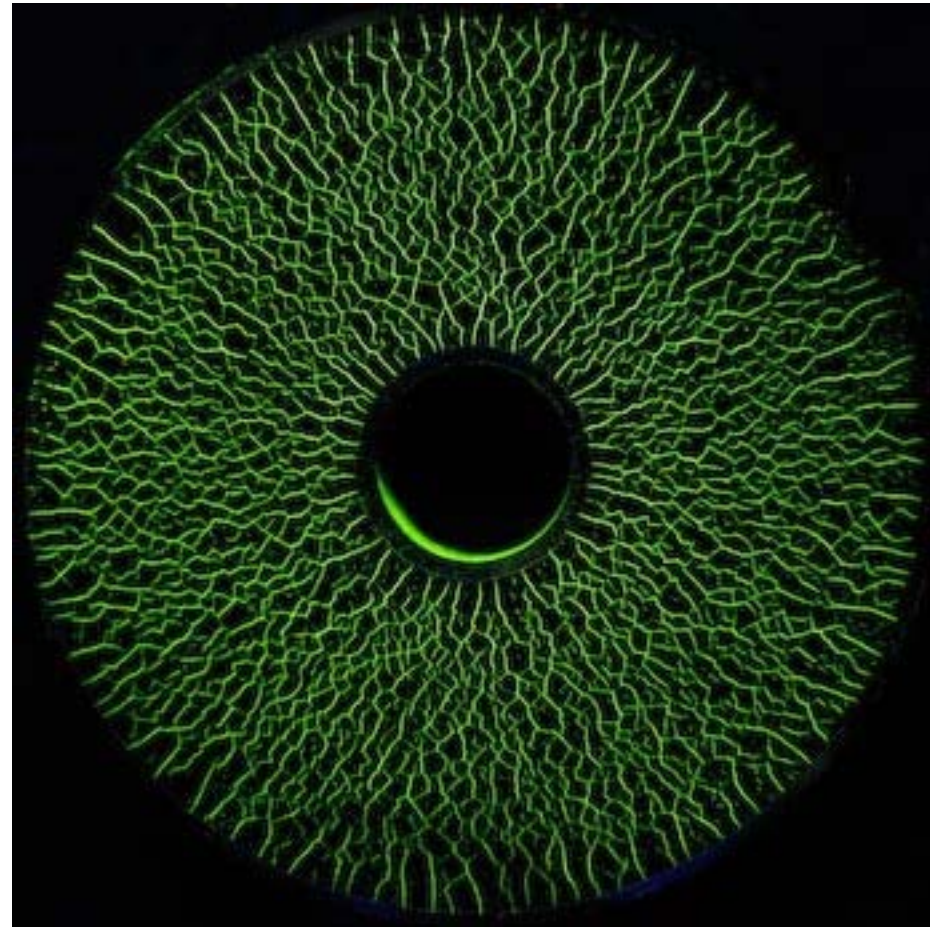

Le prove effettuate

Foto A): blocco di riferimento tipo 1 della ISO 9934-2 (ASTM E 1444)

Luce UV: 15 W/m²; Luce bianca: < 20 Lux

G8 (riferimento posto a "100")

FW1 (polvere ad Alta Luminosità)

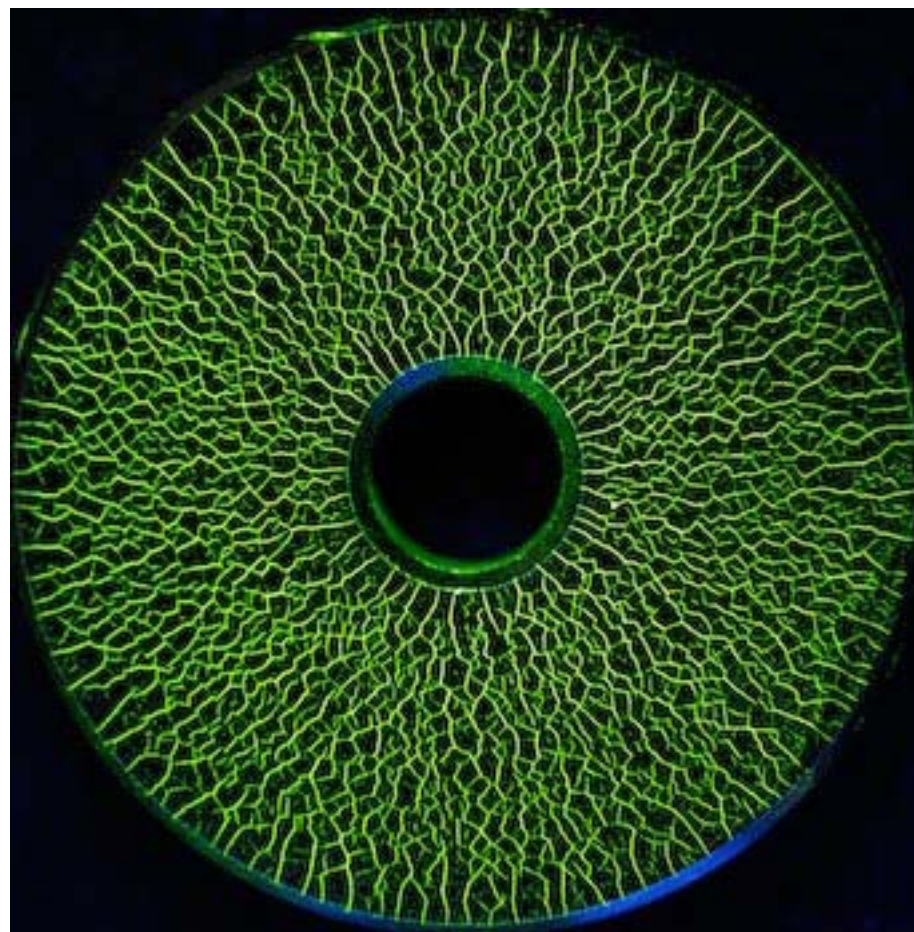
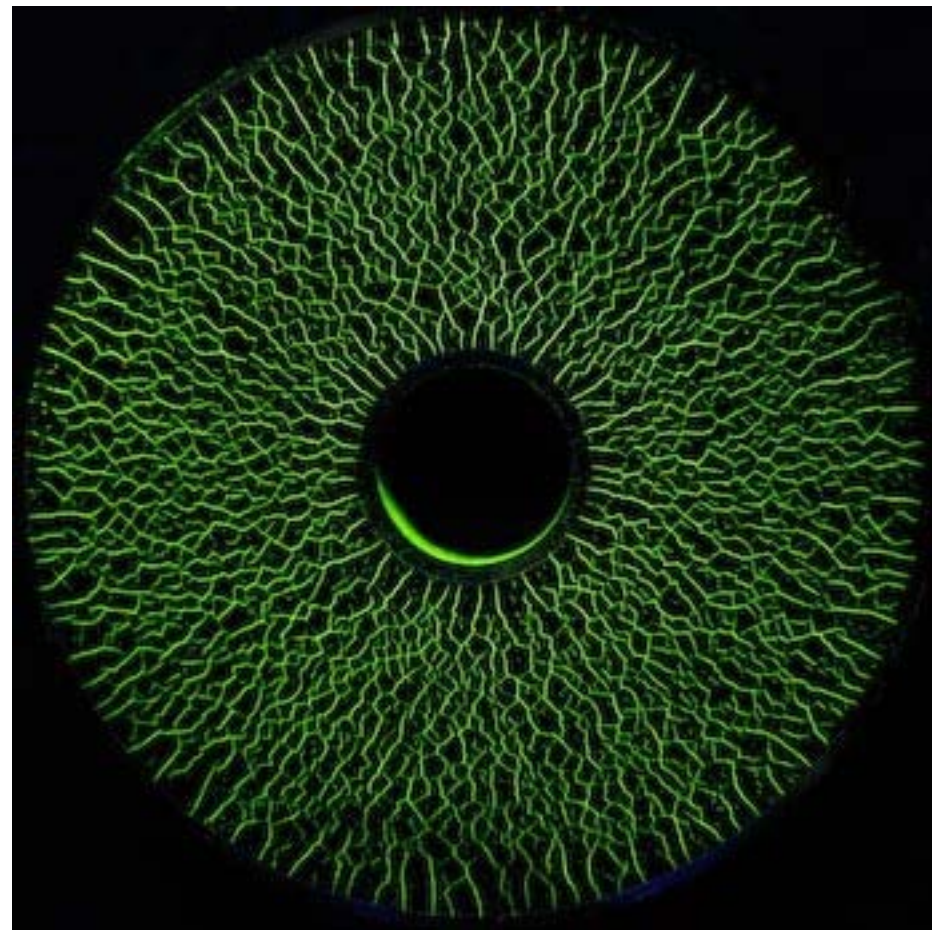

Le prove effettuate

Foto A): blocco di riferimento tipo 1 della ISO 9934-2 (ASTM E 1444)

Luce UV: 15 W/m²; Luce bianca: < 20 Lux

G8 (riferimento posto a "100")

L (polvere ad alta luminosità ma alto sottofondo)

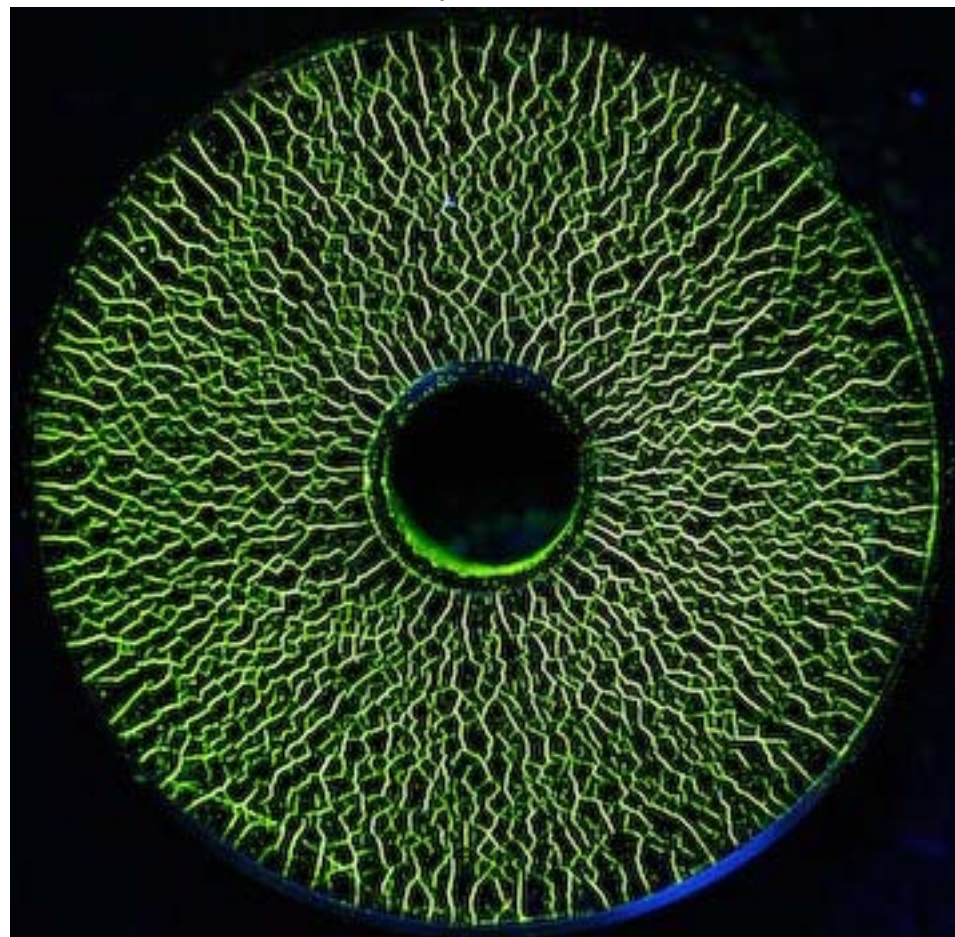
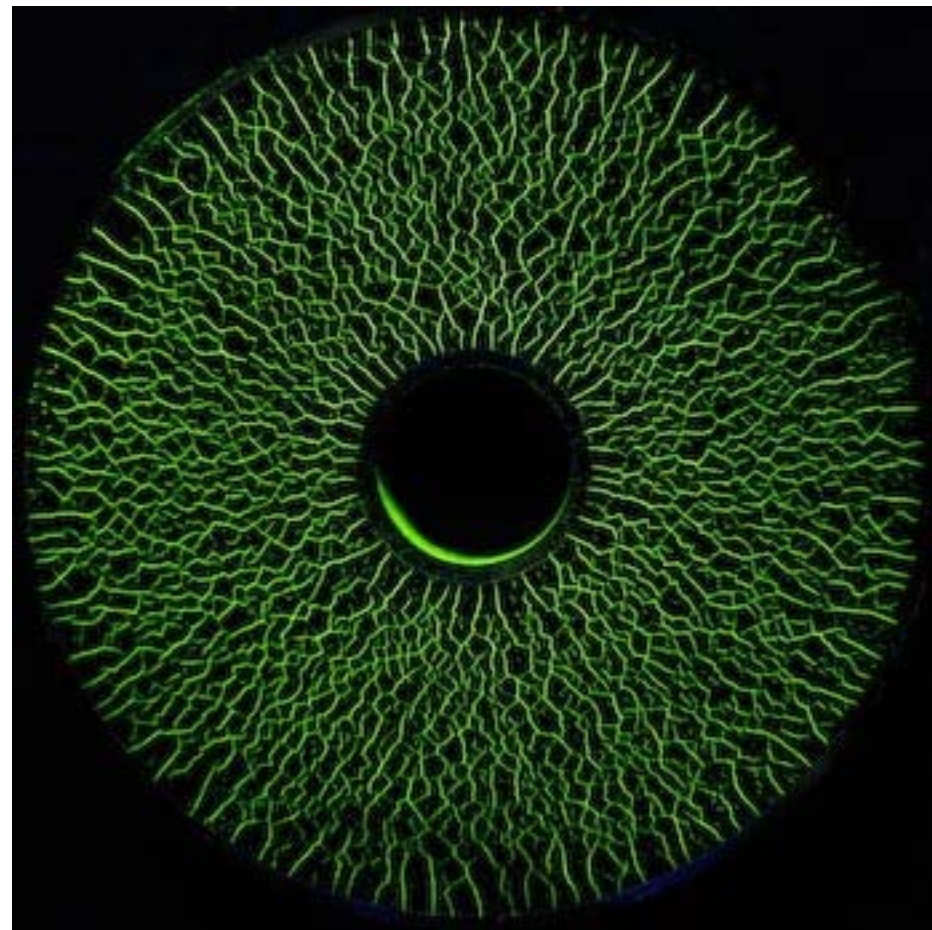

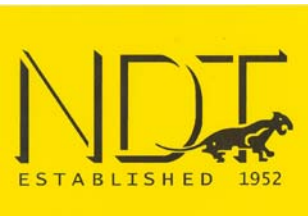

Le prove effettuate

Foto B): Magnetic Stripe Card (ASTM E 709 – ISO 7810)

Luce UV: 15 W/m²; Luce bianca: < 20 Lux

G8 (riferimento posto a "100")



C1 (polvere a bassa luminosità)



FW1 (polvere ad Alta Luminosità)

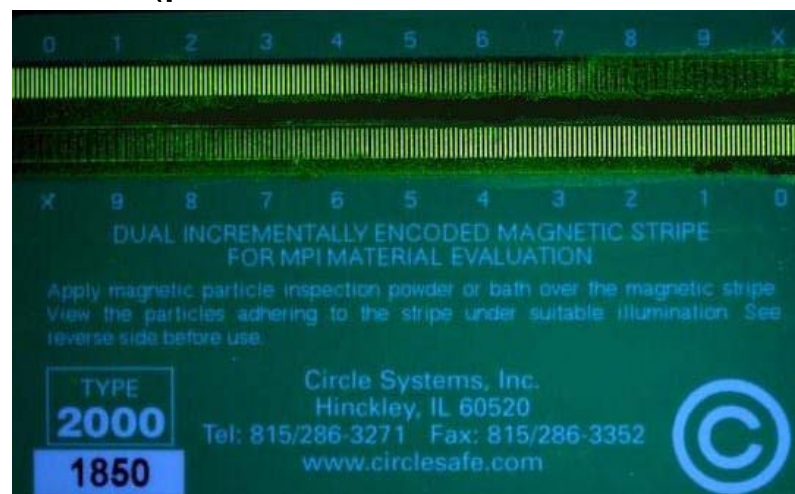

L (polvere + alta luminosità + sottofondo)

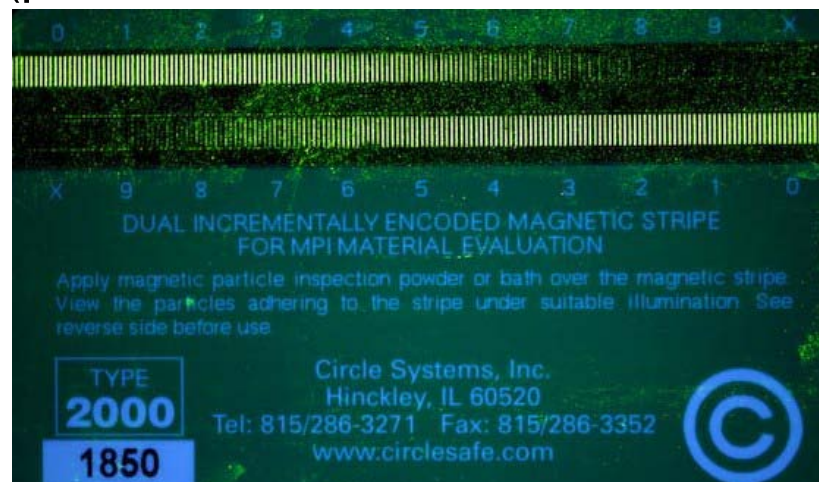

Le prove effettuate

Foto C): Difetti Artificiali "Shims" (ASME V Art. 7 T-764. 1.2.2)

FW1, G6, BW2: Luce Bianca @ 500 Lux

Elite BW2 + WBL5 (metodo visibile)



G6 (Dual Color "rossa")



FW1 (Dual Color "verde")

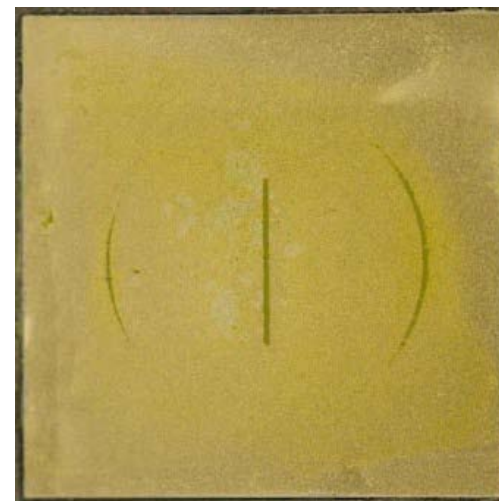

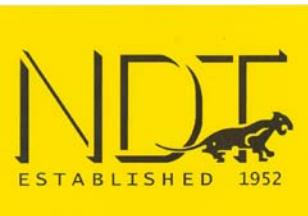

Le prove effettuate

Foto D): Difetti Artificiali "Shims" (ASME V Art. 7 T-764. 1.2.2)
Qualifica per uso PMF in area "non oscurata" (Luce visibile >20 Lux)

FW1 con Luce UV 15W/m²
Luce Bianca < 20 Lux

FW1 con Luce UV 30W/m²
+ Luce Bianca 2.000 Lux

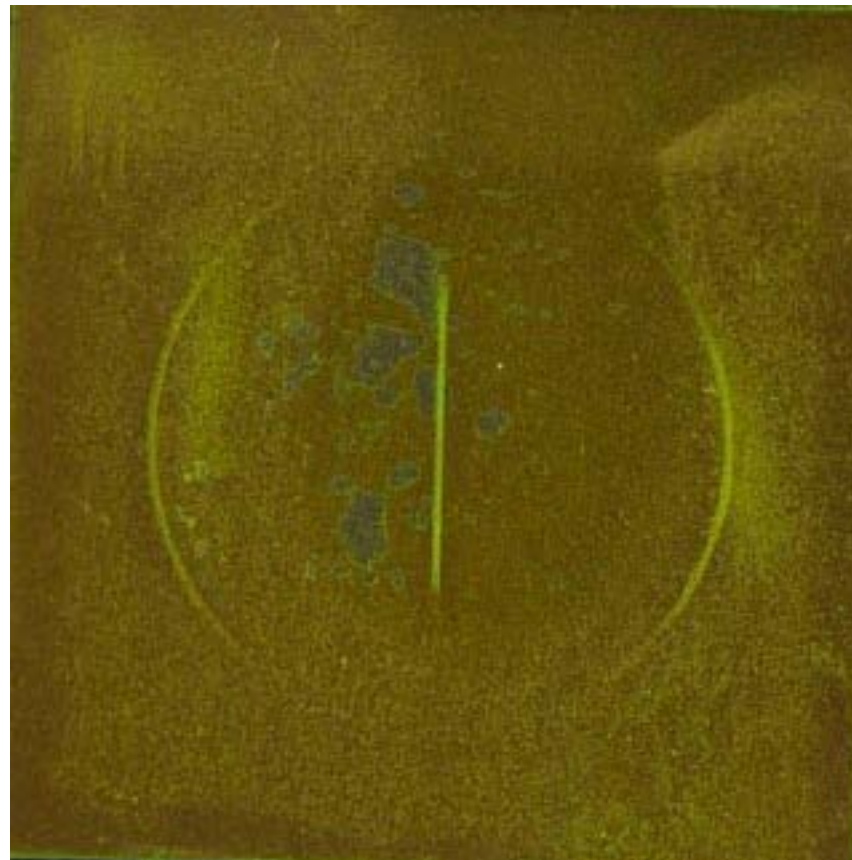



Le prove effettuate

Foto E): Fotofluorimetro S-291 (ASTM E-1135)

Modificato per l'utilizzo anche con lunghezza d'onda "blu" (450 nm)



Valutazione della Luminescenza di PMF

Luce UV (365 nm) versus Luce Blu (450nm)

Sigla	Luce U.V. 365nm	Luce Blu 450 nm
G 8	100 (posta a 100 come riferimento)	100
G 9	180	180
G 6	60	100
M 1	70	80
M 4	140	180
L	300	500
A	40	50
K	90	100
C 1	50	60
FW 1 *	220	400

* La FW1 fa parte della linea Elite prodotta dalla NDT ITALIANA

Le prove effettuate

Foto F): blocco di riferimento tipo 1 della ISO 9934-2 (ASTM E 1444)
Con luce BLU (450 nm) versus Luce UV tradizionale (365 nm)

FW1 (polvere ad Alta Luminosità)

Con Luce UV

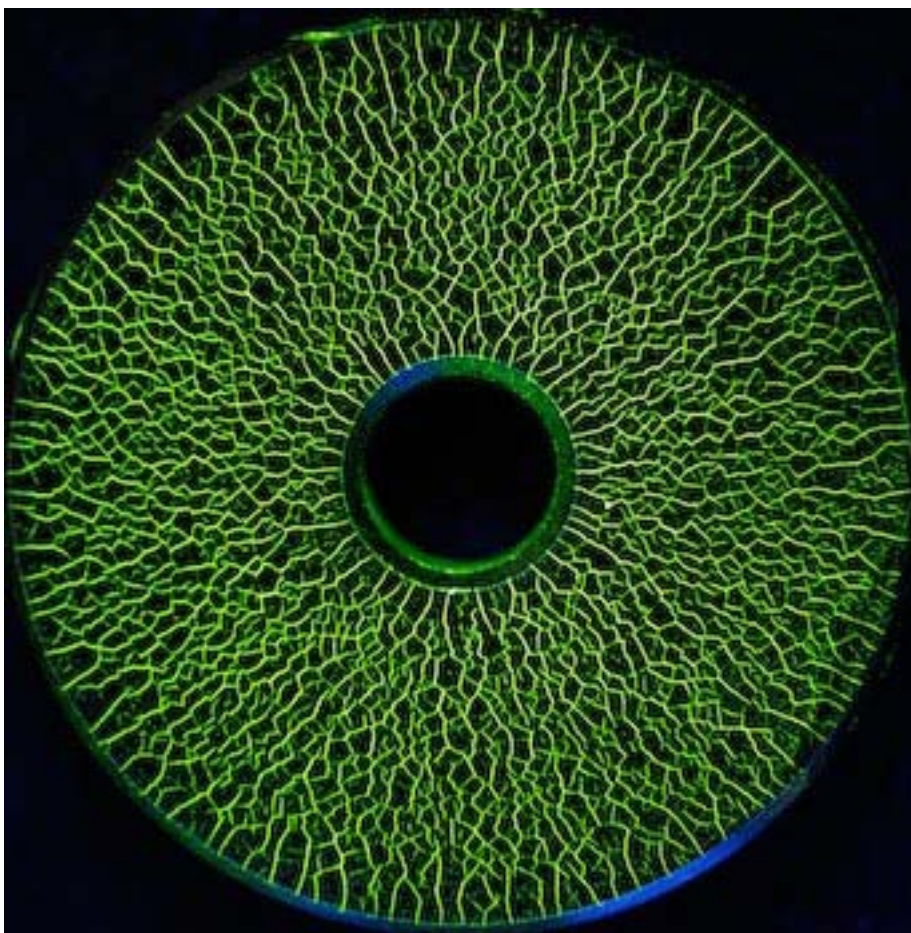

FW1 (polvere ad Alta Luminosità)

Con Luce Blu

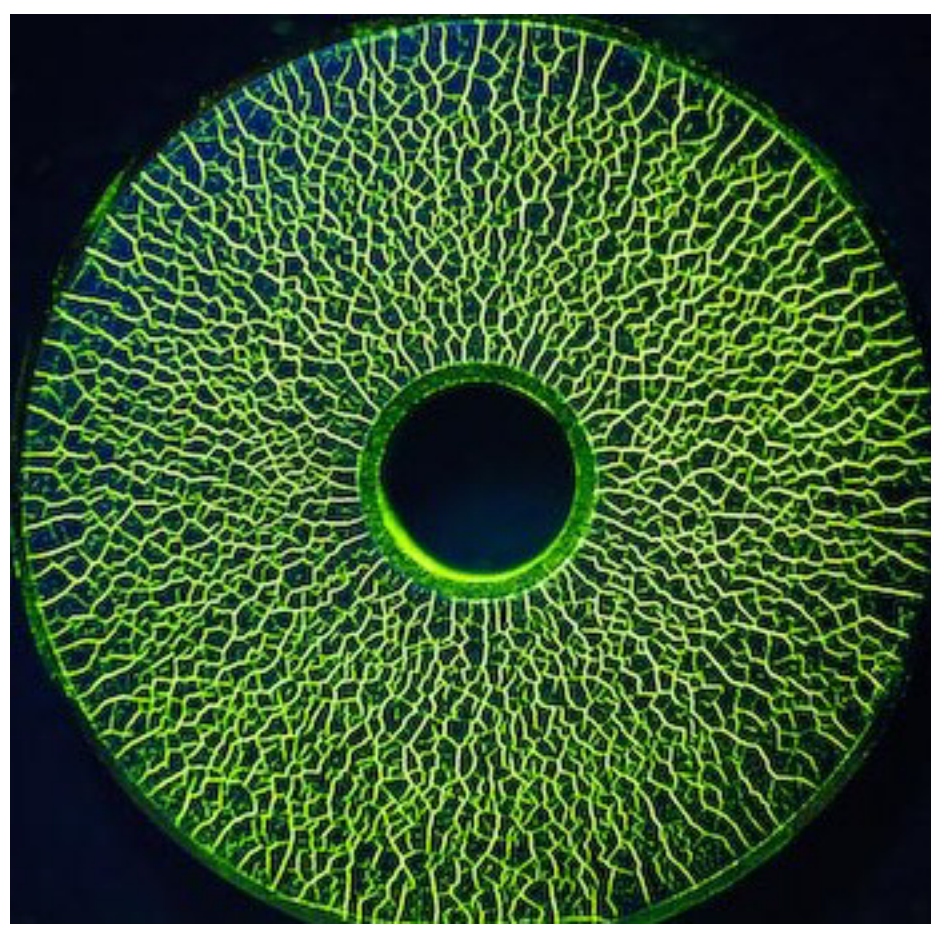

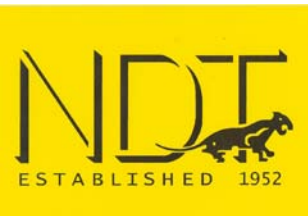

Le prove effettuate

Foto G): Difetti Artificiali "Shims" (ASME V Art. 7 T-764. 1.2.2)
Con luce BLU (450 nm) versus Luce UV tradizionale (365 nm)

FW1 (polvere ad Alta Luminosità)

Con Luce UV

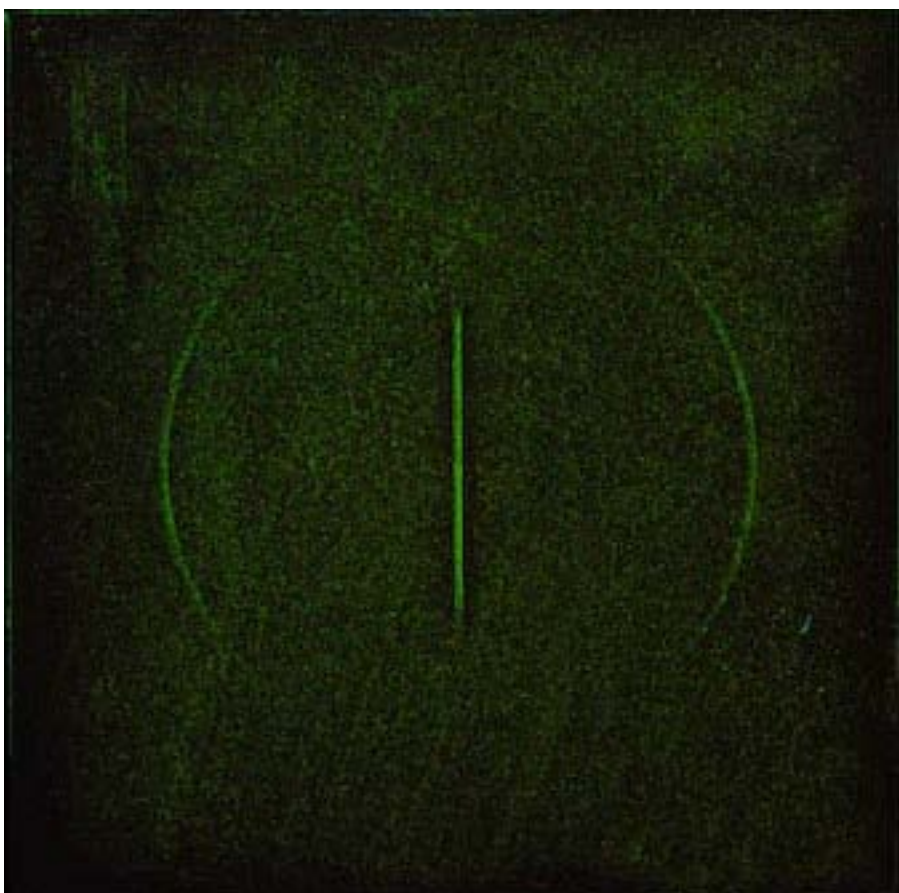

FW1 (polvere ad Alta Luminosità)

Con Luce Blu

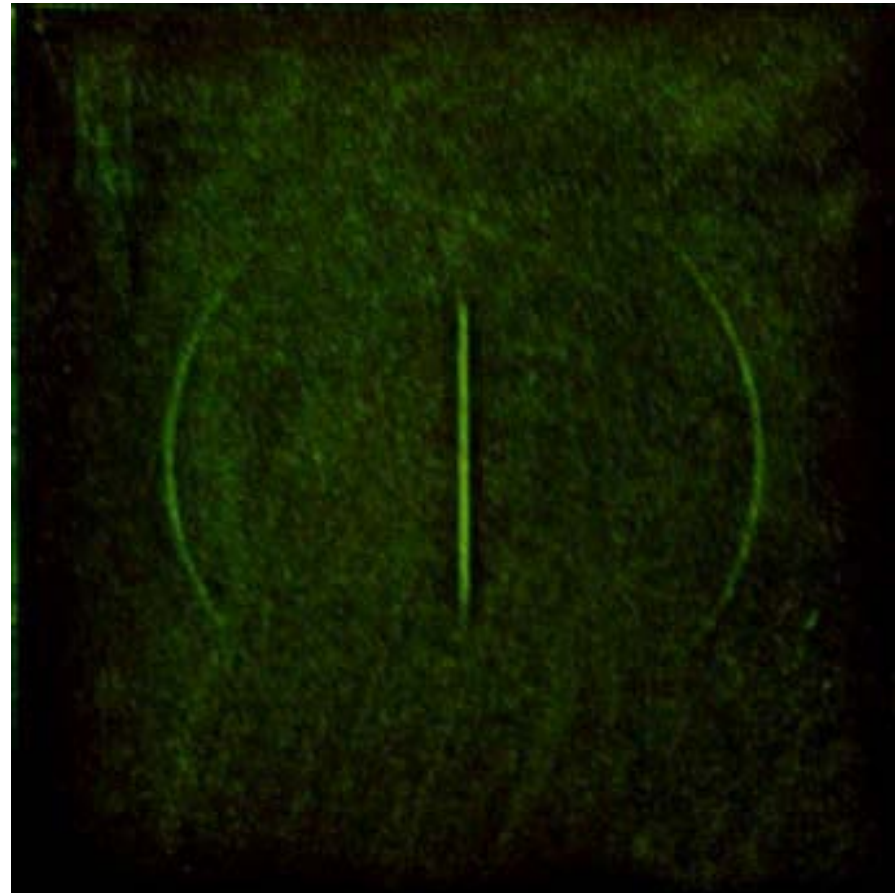

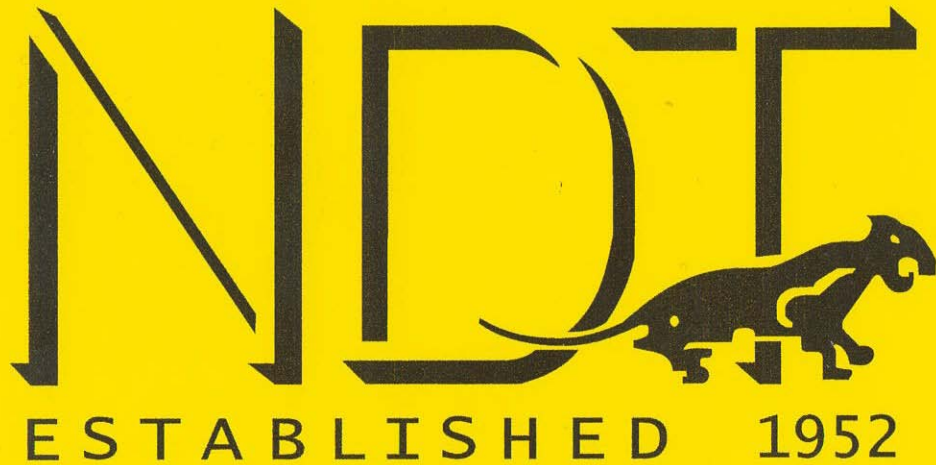

WWW.NDT.IT

info@ndt.it

Facebook Group "NDT Italiana"

Maurizio Cevenini

Michele Cevenini

***NDT ITALIANA Proudly Supports Beat Leukemia ONLUS www.beat-leukemia.org
"The difference between difficult and impossible is that impossible takes longer.
Miracles just require faith"***